

Product Guide

IMAGE-LED Lighting System

LAINI RGB

CODE : LA-12055~60



CELL INTERNATIONAL www.zcell.kr

304-1 Ohyang-Ri Silchon-Eup Gwangju-Si Gyeonggi-Do 464-875 Korea, Tel 031-764-8442, Fax 031-764-8443 Email cell@zcell.kr

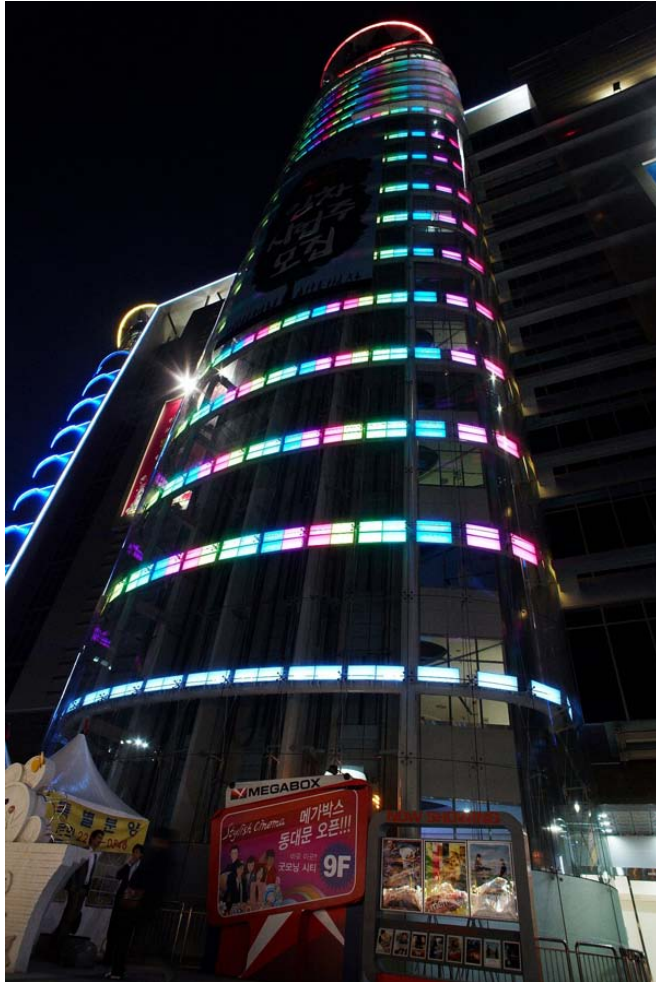

LAINI RGB

is ultra slim and linear type of pixel and to be applied for conceptual and architectural Images on any building facade, silhouette of artful object, skyline in city and line of bridge and street even as reflected lighting fixtures for internal interior design.

has 3 different lengths in accordance with its variable purposes as 225, 450 and 900mm and two models by color - RGB color model as BOKY and Single color model. diffusion - Frost and Clear (transparent) type of covering cap.

1. MODEL

IMAGE-LED FIXTURE

LA-12055	LAINI 225 RGB CLEAR
LA-12058	LAINI 225 RGB FROST
LA-12056	LAINI 450 RGB CLEAR
LA-12059	LAINI 450 RGB FROST
LA-12057	LAINI 900 RGB CLEAR
LA-12060	LAINI 900 RGB FROST

ACCESSORIES

- LA-23062	LAINI BRACKET
------------	---------------

CONTROL SYSTEM

- CT-15021	Z-SUB CONTROL
- CT-15022	Z-PROCESSOR
- CT-15023	Z-WORKS
- PW-15001	SMPS&CONTROL BOX
- PW-15002	SMPS BOX

2. SPECIFICATIONS

- Length of RGB color model : LAINI 225mm, 450mm, 900mm
- Length of Single color model : LAINI 270mm, 540mm
- Ultra slim aluminum profile body and PC UV or PMMA UV covering cap (Frost or Clear)
- No need to feed the addresses of control by automatic system of communication
- Connection between units by just one line of cable (Daisy Chain)
- Creation of artful letters, pictures and moving images through control system
- IP65 for LAINI body and Power Box

3. TECHNICAL DATA (225/450/900)

- PRODUCT CODES : LA-12055~60
- MATERIAL : Aluminum Body with Clear(Frost) PC windows
- DIMENSIONS : 235mm x 22mm x 35mm /
460mm x 22mm x 35mm /
910mm x 22mm x 35mm
- WEIGHT : 170g / 230g / 380g
- PROTECTION CLASS : IP65, Class I
- OPERATING TEMPERATURE : -20°C~65°C
- POWER SUPPLY : DC 24V
- POWER CONSUMPTION : 4W Max / 8W Max / 15W Max
- LED : RGB 3in1 SMD 10LED / 20LED / 40LED
- VIEW ANGLE : 140°x140°
- CONTROL : IMAGE-LED Protocol

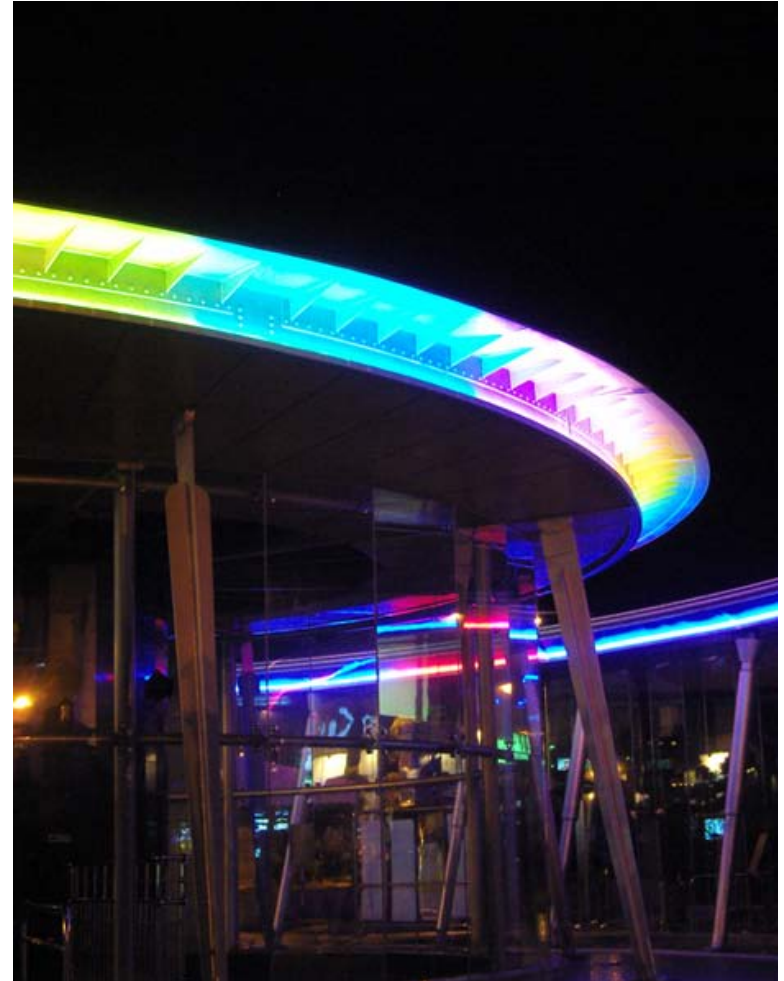

4. DRAWING & MOUNTING DIAGRAM

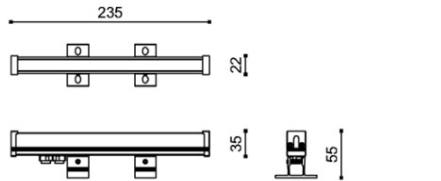

LAINI 225 RGB

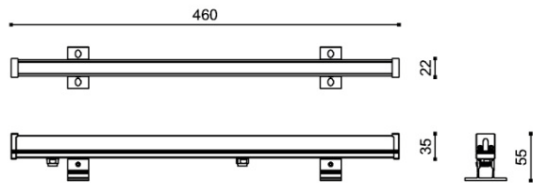

LAINI 450 RGB

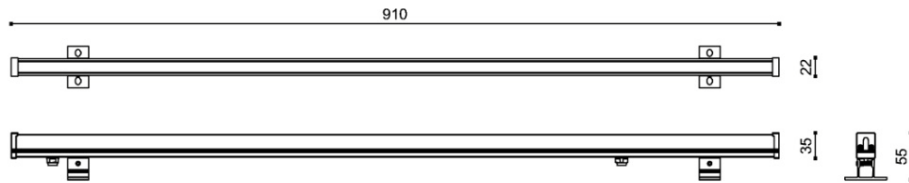

LAINI 900 RGB

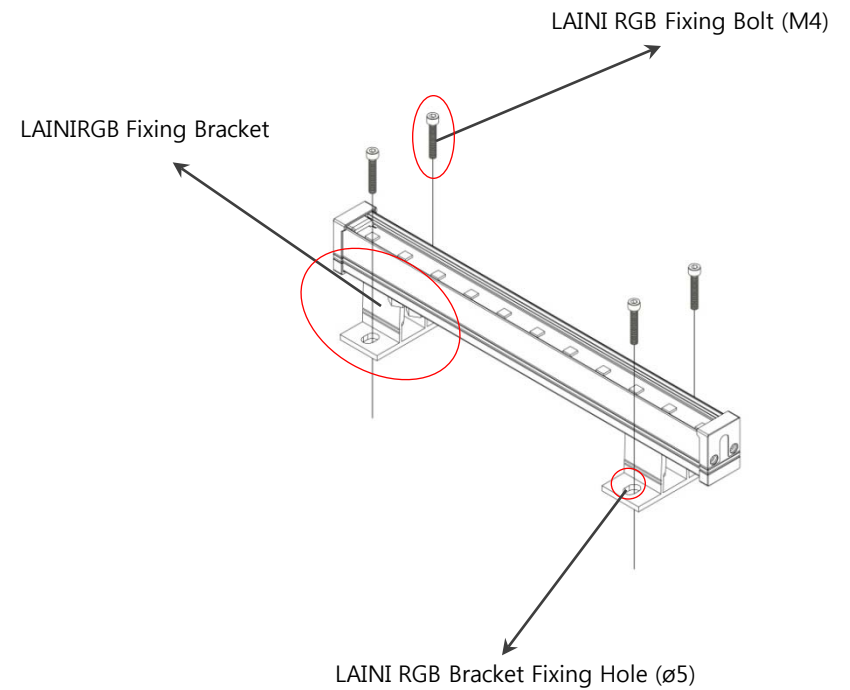

5. WIRING DIAGRAM

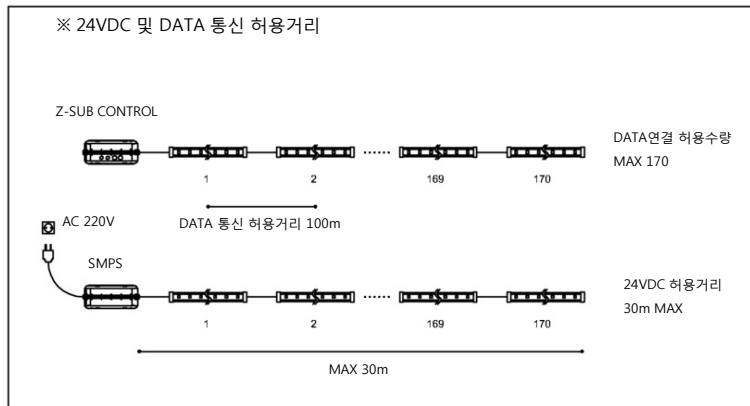
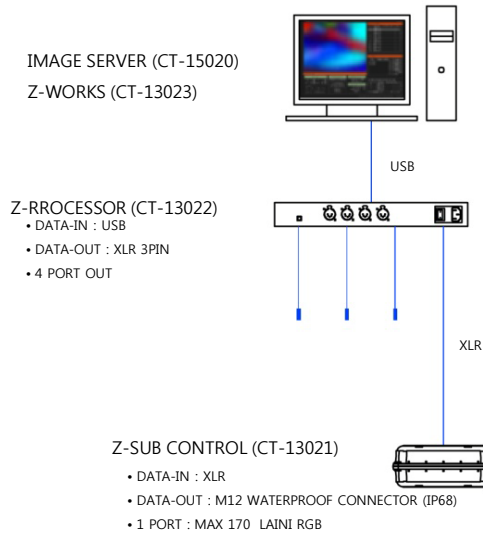

※ EXAMPLE – LAINI RGB 210set

